

linear dimension(Tolerances Standard GB/T 14486-2008)								—		
variable range		over 6	over 10	over 30	over 60	over 100	over 160		over 10	over 100
	to	to 6	to 10	to 30	to 60	to 100	to 160	to	to 10	to 100
tolerance	±0.20	±0.30	±0.50	±0.70	±1.00	±1.30	±1.60	0.10	0.30	0.60

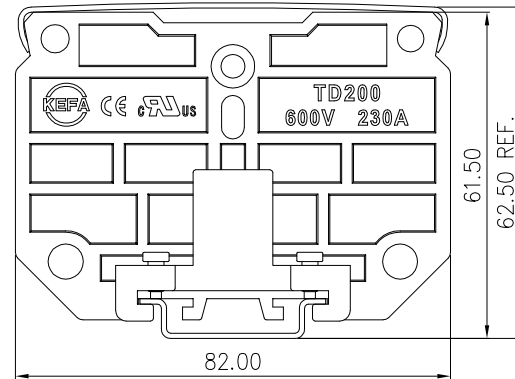
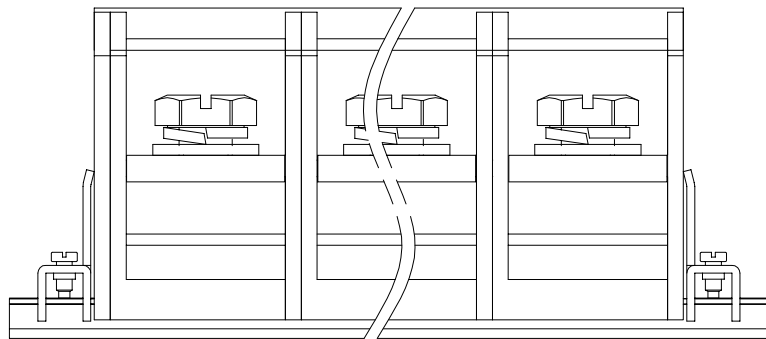
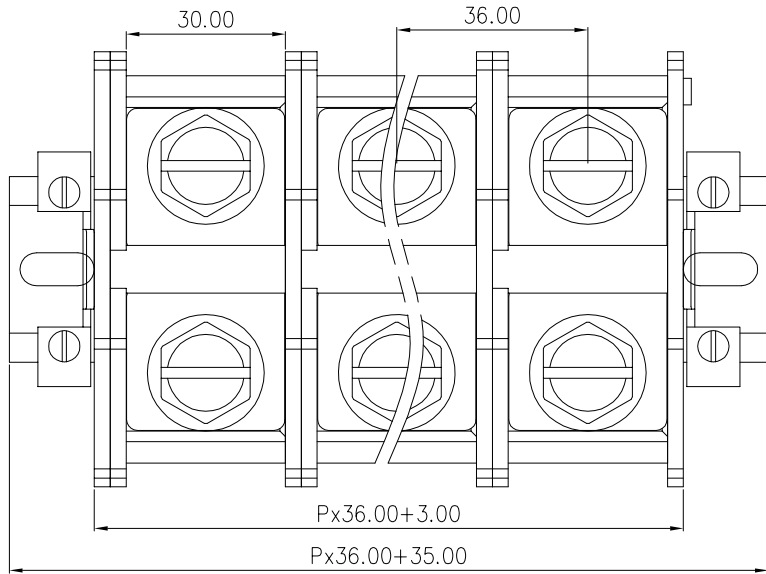

REVISION RECORD				
REV.	DESCRIPTION	ECN No.	APPROVED	DATE
A	新发行		CLF	22.05.09

UL/CUL 技术参数				
UL/CUL Technical Data				
等级	Use Group	B	C	D
额定电压	Rated Voltage [V]	600	-	-
额定电流	Rated Current [A]	230	-	-
接线范围	Wire Range	8-4/0		
单/多芯线	Solid/Stranded [AWG]			
IEC 技术参数				
IEC Technical Data				
额定电压	Rated Voltage [V]	1000		
额定电流	Rated Current [A]	230		
耐电压	Withstanding Voltage	3500V/1Min		
导线截面积	Conductor cross section	100.0		
硬质/柔性导线	Solid/flexible [mm ²]			
材料		Material		
绝缘材料	Insulation Material	PC		
阻燃等级	Imflamability	UL94V-2		
导体材料	Contacting Material	铜合金 Copper alloy		
导体表面镀层	Contactive Coating	镀镍 Ni Plated		
一般参数		Other Data		
间距	Pitch [mm]	36.0		
极数	Poles [P]	01-XX		
剥线长度	Stripping Length [mm]	-		
螺丝	Screw/扭矩 Torque(Max) [N.m]	M10/10.0		
工作温度	Operating temperatur [°C]	-40~+125		
引针尺寸	Pin Dimensions [mm]	-		
PCB板孔径	PCB Hole Diameter [mm]	-		

DES.	LQQ	DATE	22.05.09	单位 / UNITS	mm	尺寸 / SIZE	A4	比例 / SCALE	1:1	第三视角 / THIRD ANGLE PROJECTION	版本 / REV	A
CHK.	BY	DATE	22.05.09		慈溪市科发电子有限公司 CIXI KEFA ELECTRONICS CO., LTD			名称 / TITLE	TD200-41-DG-36.0			
APP.	CLF	DATE	22.05.09									