

linear dimension(Tolerances Standard GB/T 14486-2008)							— 			
variable range	to 6	over 6 to 10	over 10 to 30	over 30 to 60	over 60 to 100	over 100 to 160	to 10	over 10 to 100	over 100 to 100	
tolerance	±0.20	±0.30	±0.50	±0.70	±1.00	±1.30	±1.60	0.10	0.30	0.60

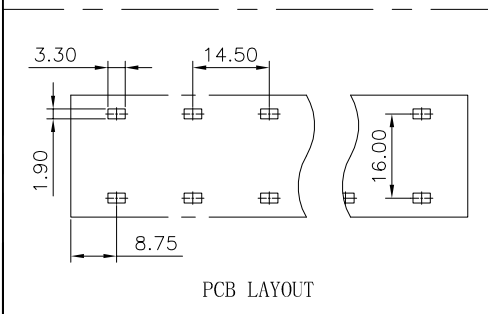
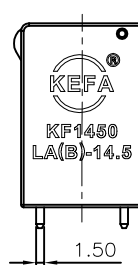
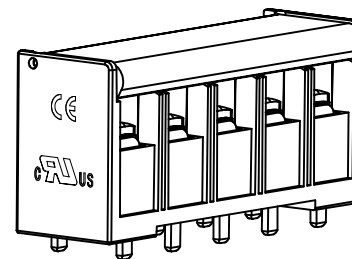
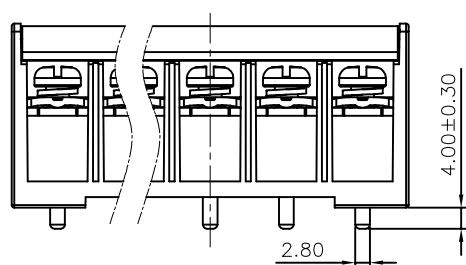
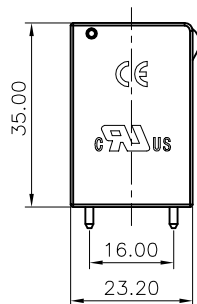
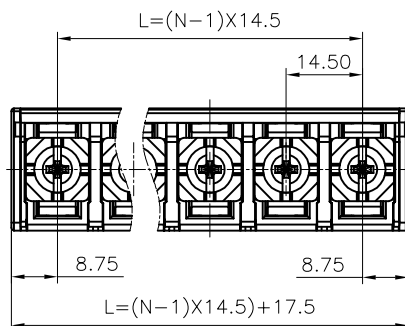

REVISION RECORD				
REV.	DESCRIPTION	ECN No.	APPROVED	DATE

UL/CUL 技术参数				
UL/CUL Technical Data				
等级	Use Group	B	C	D
额定电压	Rated Voltage [V]	300	300	300
额定电流	Rated Current [A]	50	50	10
接线范围	Wire Range	20-8		
单/多芯线	Solid/Stranded [AWG]	20-8		
耐电压	Withstanding Voltage	AC 2.2KV/ 1 min		

IEC 技术参数				
IEC Technical Data				
过电压类别	Overtoltage Category	III	III	II
污染等级	Contamination Class	3	2	2
额定电压	Rated Voltage [V]	630	1000	1000
额定电流	Rated Current [A]	76	76	76
额定冲击电压	Impulse withstand voltagea [KV]	6	6	6
导线截面积	Conductor cross section	0.5-16		
硬质导线	Flexible [mm ²]	0.5-16		
柔性导线	Solid [mm ²]	0.75-16		

材料		
绝缘材料	Insulation Material	PBT-4830
阻燃等级	Imflammability	UL94V-0
导体材料	Contactior Material	铜合金 Copper alloy
导体表面镀层	Contactive Coating	镀锡 Tin plating

一般参数		
间距	Pitch [mm]	14.5
极数	Poles [P]	2~16P
剥线长度	Stripping Length [mm]	13
螺丝	Screw/扭矩 Torque(Max) [N.m]	M5/2.0
工作温度	Operating temperatur [°C]	-30°C~ +120°C
引针尺寸	Pin Dimensions [mm]	4.0
PCB板孔径	PCB Hole Diameter [mm]	1.9x3.3

DES.	CHK	DATE	2024. 11. 29	单位/ UNITS	mm	尺寸/ SIZE	A4	比例/ SCALE	1:1	第三视角/THIRD ANGLE PROJECTION	版本/	A
CHK.	CLF	DATE	2024. 11. 29	 慈溪市科发电子有限公司 CIXI KEFA ELECTRONICS CO., LTD						名称/	REV	A
APP.	HDK	DATE	2024. 11. 29					名称/	TITLE	KF1450LB-14.5-XXP黑色		